

## Theme 8: Animal housing

# CONSTRUCT SMALL ZERO GRAZING UNIT (Level 2)

Topic	Training & information Content
8.1	Farm structures & housing cows/calves/young stock
8.2	Construct small zero grazing unit (SNV handbook)
8.3	Prevention of heat stress in cow barns
8.4	Cow house ground floor plan design (SNV book)
8.5	Best management practice feed fences
8.6	Housing & cow comfort (animal welfare)
8.7	Housing & reduction greenhouse emissions
8.8	Use of sensors (activity meter) in dairy herds



## 1. You will learn about (learning objectives):

- What to consider before constructing a zero-grazing unit.
  - basic principles of good cow barn design and types of barns for the cow and youngstock.
  
- Units to consider while designing farm structures.
  - Examples of smallholder cow barn designs and several types of materials used.



## 2. Background

- A cow barn requires a considerable investment. A proper design is crucial for cow comfort and health, optimal production and profitability of the enterprise.
- Provided there is a proper site plan with “space to grow”, each module/barn can be enlarged easily at minimum costs and adjustments (or even demolition) of existing structures.
- Use this link to download the handbook, <https://cowsoko.com/programs/kmdp/publications/128/item>.



### 3. Introduction to smallholder zero grazing unit

- The zero grazing unit is a shelter for animals that protects against unfavorable weather conditions e.g. heat, rain, wind and is well ventilated at the same time.
- A zero grazing unit needs to be designed in such a way that it can accommodate animals of all age groups separately. It also allows the animals to walk freely all year round and has facilities for all animals to rest.
- Resting, walking, feeding and milking areas need to provide cow comfort for maximum milk production.
- At the same time it must facilitate labour processes e.g. milking, feeding, and manure collection, in a safe and efficient manner.

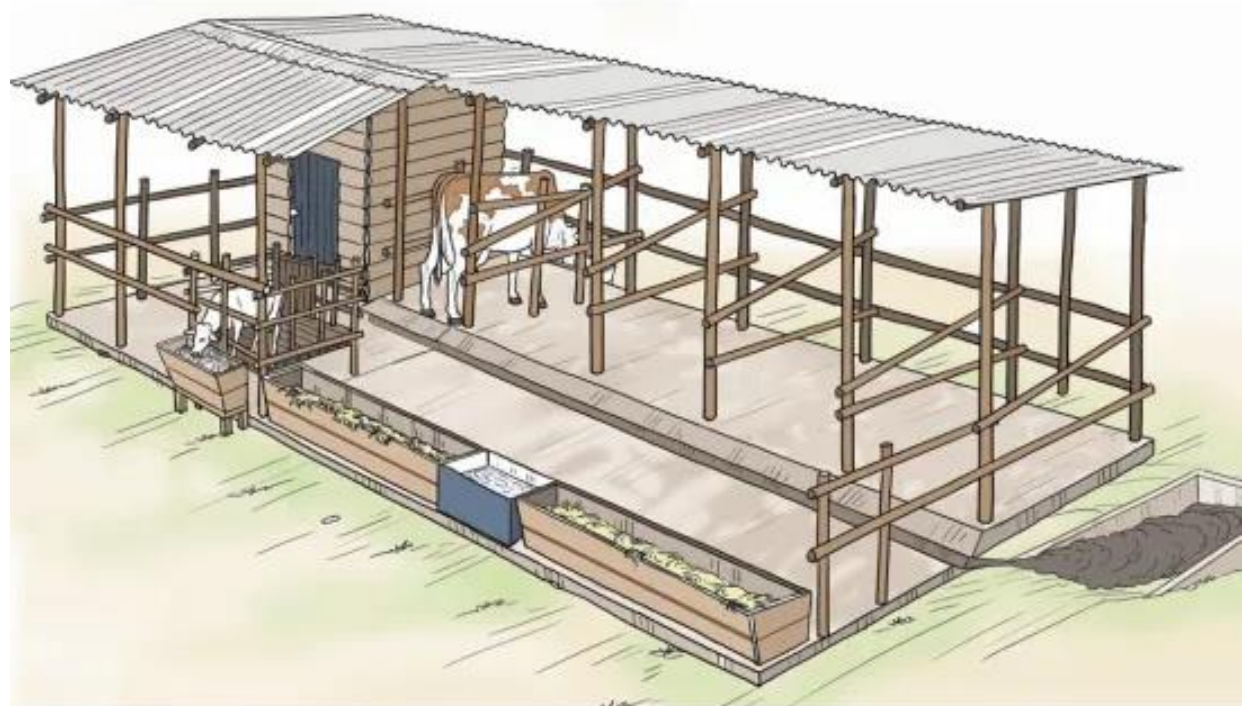



## 4. Basic principles of Cow barn design

- There are four (4) basic principles for good cow barn design that are universal, can be summarized as follows;
  - i. Cows must be comfortable,
  - ii. The structure is flexible and expandable,
  - iii. The structure is simple, robust and economical,
  - iv. Allows optimization of movements/flow and labour efficiency.



## 5. Site plan

- The 4 basic principles, in particular expandability and separation of flows, require a good survey of the site and a proper site plan.
- The importance of this cannot be emphasized enough, as it forms the basis for future growth and expansion and separation of clean and dirty flows (milk, feeds, manure).
- An example of this is given in the figure on the right and arrows represent the flow.

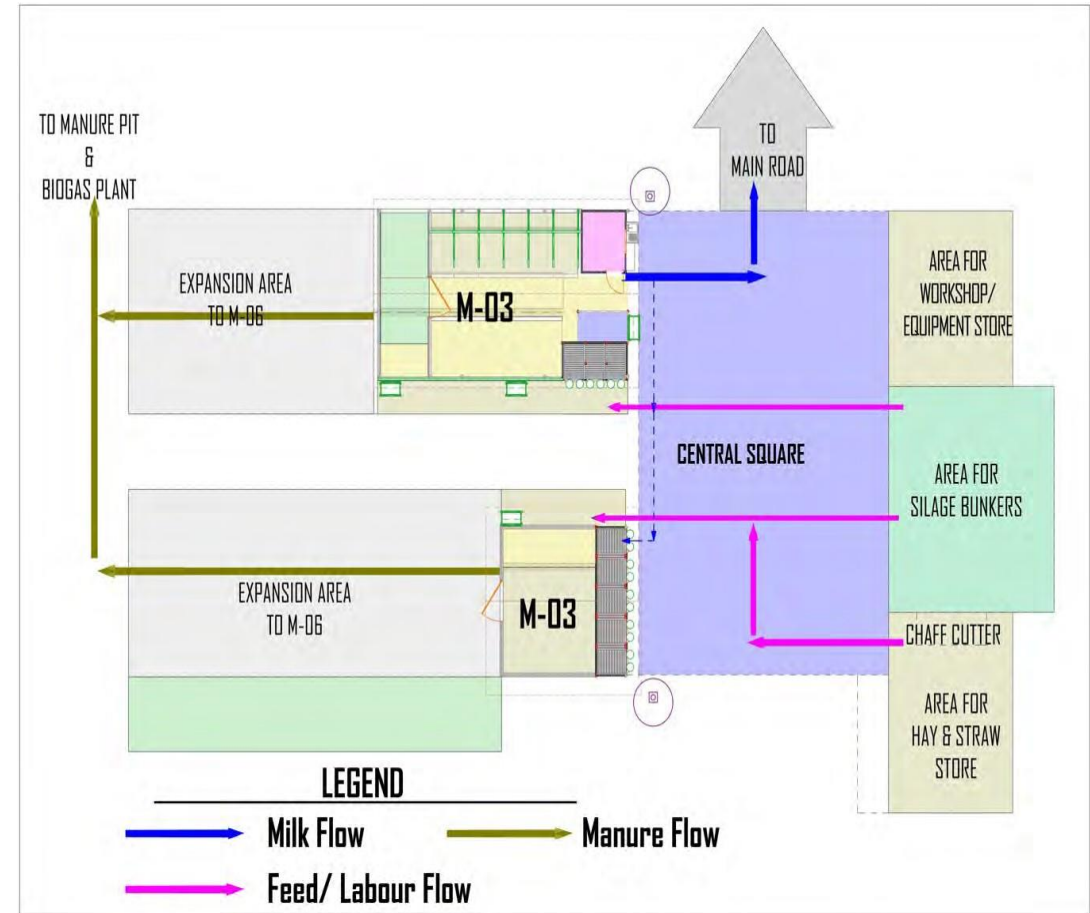

## 6. Cow comfort

- Cow comfort means the cow lives in an environment where she is comfortable and enjoys living without stress.
- The farmer should consider the following pointers for a cow to be comfortable;
  - Provide adequate space. Space for ease to rest and movement,
  - Available and accessible feed and water,
  - A barn with a flow of fresh air and light,
  - No animals should be suffering from wounds, disease and infection.





## 7. Flexible and expandable

- Simplicity of the design and setup is very important. Straight lines and dedicated areas are essential for expandability and labour efficiency.
- In the design and planning process, this cornerstone can be managed by taking into account the space and layout of the next structure (expansion).
- By doing so the farmer anticipates the future growth of the herd and the dairy enterprise. He/she should explore various growth scenarios.
- In relatively compact barn set-ups, multi-tasking is an important fact. The working environment must be open and easy to clean.



Overview plan of a dairy farm, with room for expansion



## 8. Simple, robust and economical

- The barn and support structures should be functional and durable for the estimated number of years of use. This starts with the type of building materials used.
- It is however a pitfall to start with this cornerstone of construction as it should be the last phase of the design and planning process.
- Quite often there are payoffs (pros and cons) when one chooses a certain option, for example, to build in steel or wood.
- Make a list of all payoffs and evaluate these regularly before coming to final conclusions.



Which way, steel or wood?



## 9. Optimization of movements, flow and labour efficiency

- Feed flow: movement of all feed ration components (storage, feeding, cutting, mixing, feeding, etc.), feed push-ups, cleaning of feed troughs.
- Manure flow: movement of manure/urine and dirt from cleaning of floors to be separated from clean flows (milk and feedstuffs).
- Cow flow: movements of all animals during the day, during the year/seasons, and during their lives.



## 9.1 Optimization of movements, flow and labour efficiency Cont'd...

- People flow/work flow: movements of people during all the work they need to do in and around the barn.
- Materials flow: storage, use, handling, maintenance and disposal of all materials and equipment used in the barn.
- Information flow (including farm recording): how people communicate with each other, how information is registered and transferred from one person to the other, how people can easily pick up information they need in a certain situation and for a certain task.





## 10. Specific aspects for cow barn design

- A roof provides shelter against sun and rain; and can also be used to collect rainwater.
- No sidewalls, only bars to keep the animals in.
- Good flooring to collect manure and ensure cows can walk safely and comfortably.
- Comfortable cubicles (beds): soft flooring and bedding, good head-swing space.
- Accessible water points.
- Comfortable feed tables: easy to clean and for the cow to eat from.

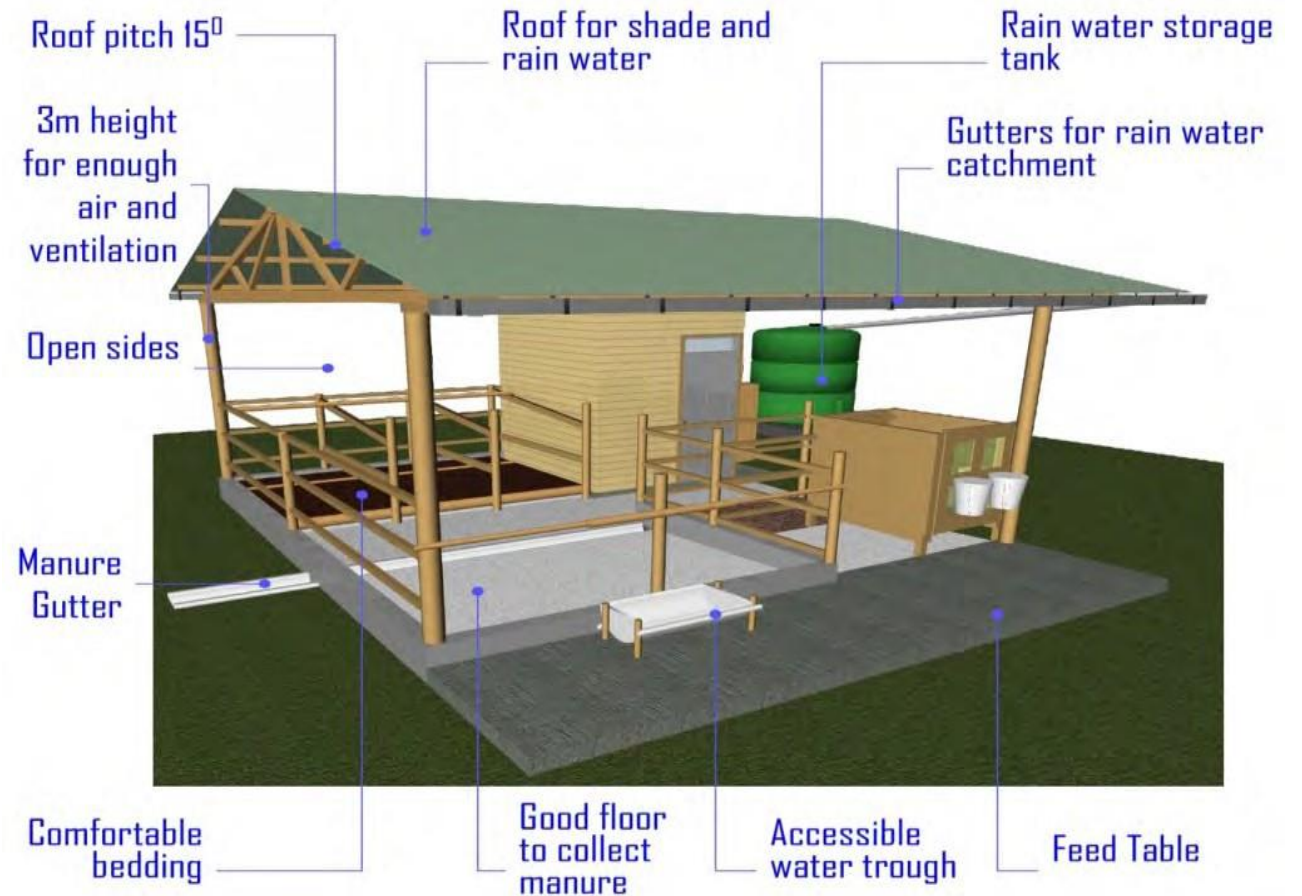



## 11. Site preparation

- The area to be constructed should be prepared in a standard way to create appropriate levels and firm ground base, onto which the concrete floor will be laid.
- Unstable ground leads to a short life span of the concrete floor through cracking and disintegration, caused by differential settlement of the ground below.
- In case the location of the farm has black cotton soil, the topsoil and any other loose soil material should be removed and replaced with appropriate backfill material such as hardcore, and compacted well to form a stable floor base.



## 12. Proposed construction materials: Wood

- Use the 150 mm thick mass concrete with BRC mesh reinforcement (Cement: Sand: Ballast 1:2:4) finished in diamond pattern groves; 12mm wide by 5mm deep and 60mm apart, plus associated short walls up to 20cm high in areas defined in the detailed design drawings.
- Treated wooden posts of 15 feet long and 15 cm in diameter on average for structure construction.
- Treated sawn timber grade 2"x4" (50mmx100mm) sections, edges planned to bevel for cow comfort, proposed for fences, cubicle dividers and gates.



## 12.1 Proposed construction materials: Wood Cont'd...

- Galvanized corrugated iron sheets, pre-painted gauge 30. Roof cover on timber structure is complete with associated accessories.
- To match the structural strength of wood, grids of 2.4 meter and 3.6 meter intervals center to center combined to form an equivalent single grid of 6 meters as used in steel, are recommended.





### 13. Proposed construction materials: Steel

- Use 150 mm thick mass concrete with BRC mesh reinforcement (Cement: Sand: Ballast 1:2:4) finished in diamond pattern grooves; 12mm wide by 5mm deep and 60mm apart, plus associated short walls up to 20cm high in areas defined in the detailed design drawings.
- Consider 4" diameter 3mm thick mild steel columns/posts; height and anchorage as per the drawings.
- 2" diameter 3mm thick mild steel pipes bent to shape to details for fences, cubicle dividers, gates.





## 13.1 Proposed construction materials: Steel Cont'd...

- Use galvanized corrugated iron (g.c.i) sheets, pre-painted gauge no. 30. Roof cover on mild steel structure to fabricator's specifications, complete with associated accessories.
- Grids of six (6) meters center to center for structural steel posts/columns forming the structure of the cow barn unit are adopted.
- This is to match standard steel members in the market. It is also a reasonable multiple of the standard width of a cubicle (1.2 meters).

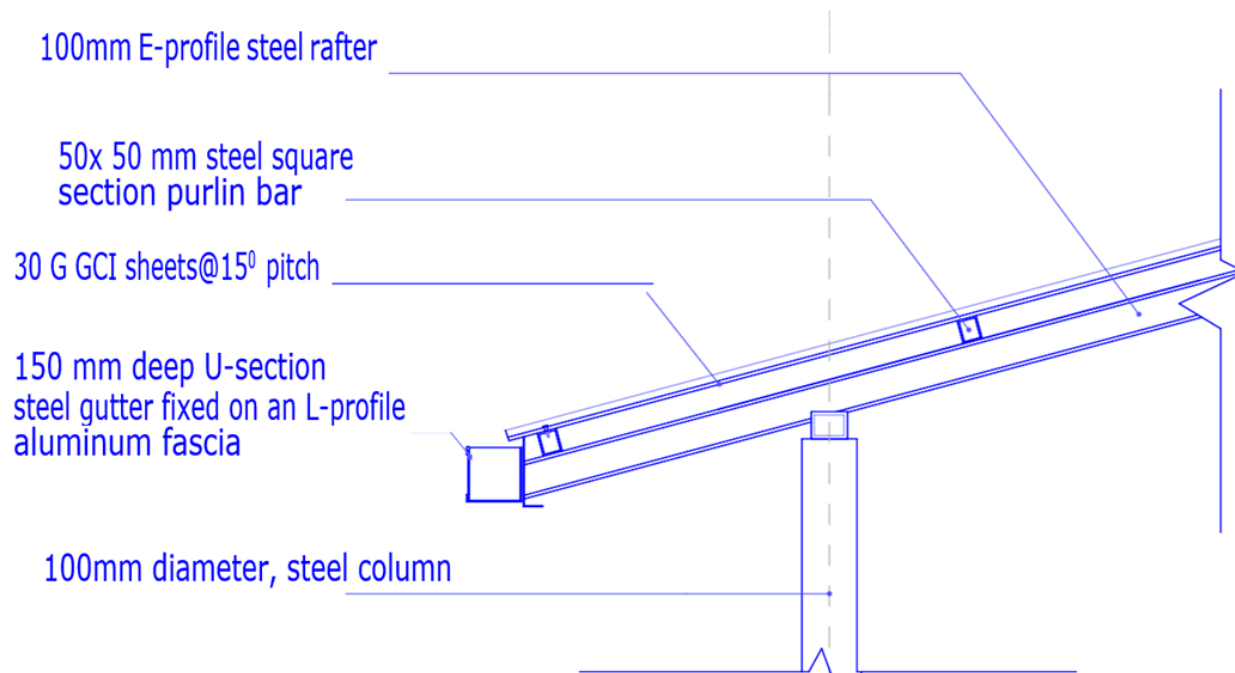

**Tip:** \*Contact your farm advisor to explain the detailed contraction information in the drawing.

## 14. Roof structure and roof covering

- The structure should be such that the lowest part (eaves) height is a minimum of three meters high and the pitch (roof slope) is 150 degrees. This allows for sufficient aeration and ventilation.
- Use overhangs and rain gutters to provide extra shade, to keep rain out and collect rainfall.
- Build the roof high, far away from the cows. High roof keeps hot air right under the roof further from the cow.
- Roof covering should be a brightly colored galvanized corrugated iron sheet. Dull coloured sheets absorb and retain solar heat, contributing to cows' heat stress. Ordinary corrugated sheets of minimum gauge 30 are recommended.

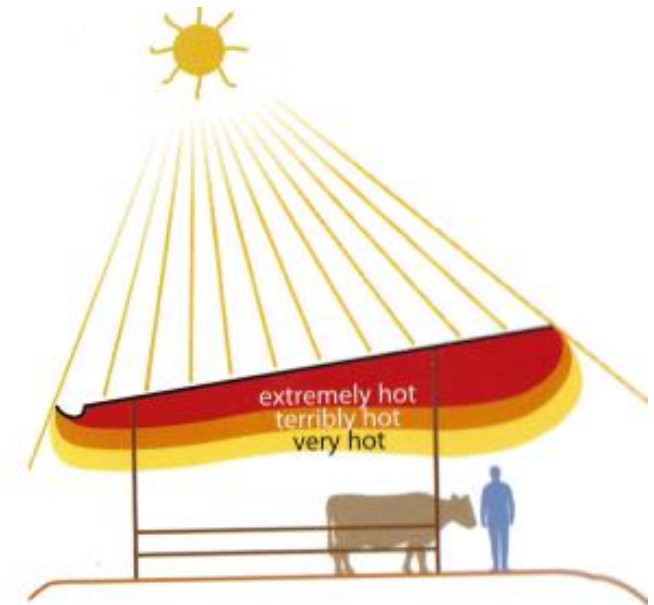
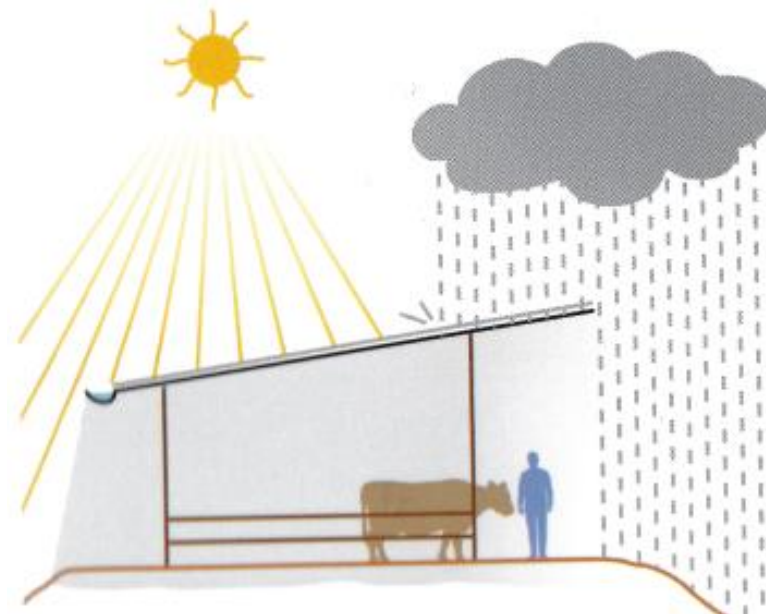

## 15. Fresh air

- A cow barn should not have walls or other obstacles that block the flow of fresh air and ventilation.
- Allow the wind and outside airflow through your barn and between the cows as much as possible.
- Build as few walls as possible. Walls are expensive to build, they block ventilation, and reduce space.
- Walls inside the barns also make it inflexible to change the size of the pens.
- Fresh air and ventilation are important for the cows' health and comfort.

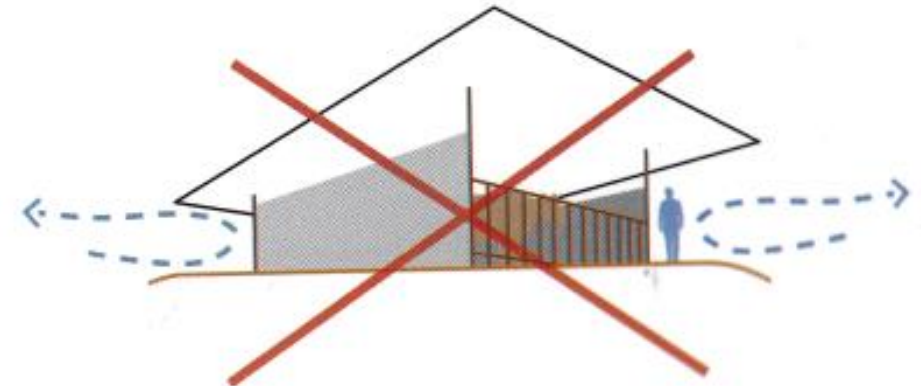
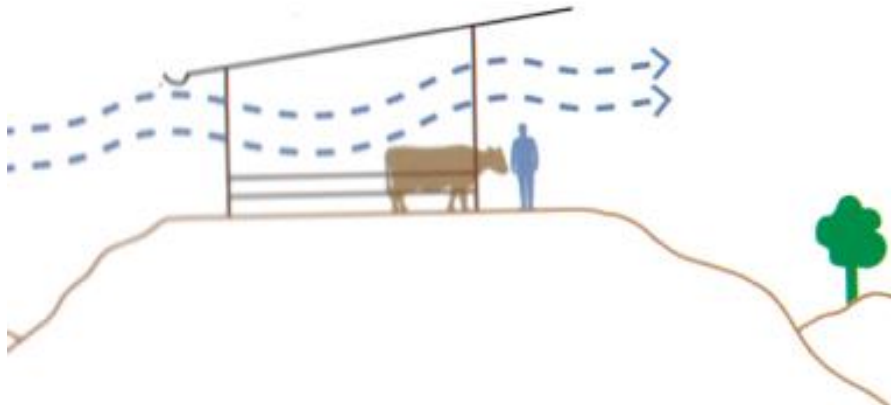
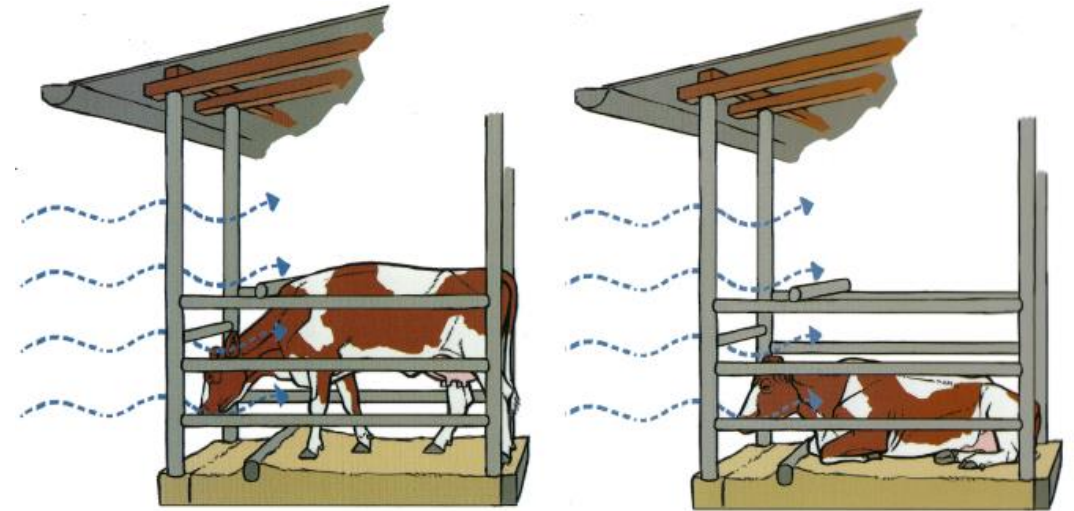

## 15.1 Fresh air Cont'd...

- When a cow lies down for fewer than 12 hours per day, she is more likely to get hoof problems and become stressed. In the pictures below there is not enough head swing for the cows to get up easily.
- Lack of ventilation and flow of air increases the cases of cows suffering from heat stress. Heat stress has a lot of negative impacts on your cows.
- In the situation shown in the pictures, the wall (and of concrete, iron sheets, wood, etc.) in front of the cow stops her from lying down and standing up easily, while also blocking the flow of air.
- The cows will also tend to avoid laying down in the cubicles and lay on the walking alley.

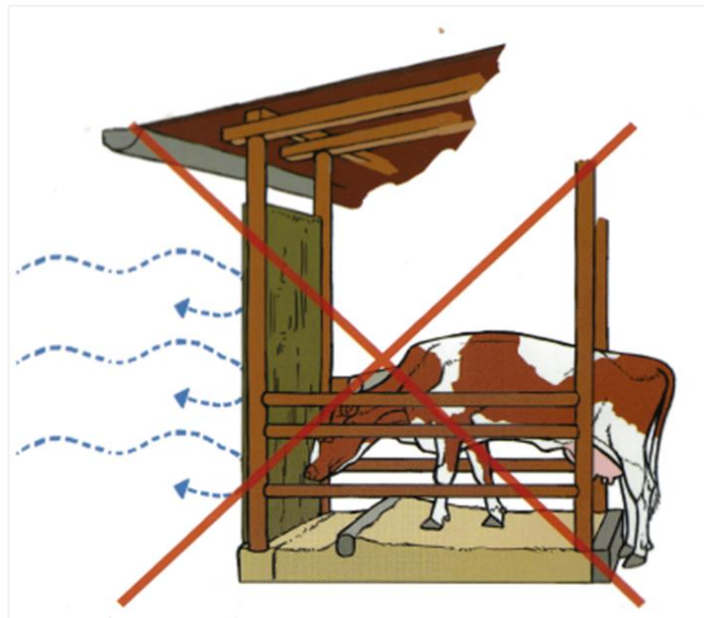



## 16. Cow barn ventilation

- Ventilation is very important to consider while constructing a cow barn. The picture below shows the flow/circulation of air circulates in a closed (indoor) cow barn.
- A good ventilation does the following;
  - i. Reduces the population of flies and spiders and webs in the barn.
  - ii. Reduces heat stress by directing hot air out through the roof and fresh cool air in the barn.
  - iii. Reduces toxic gases such as Hydrogen sulphide, Methane, Ammonia and Carbon dioxide.
  - iv. Makes the barn more durable.

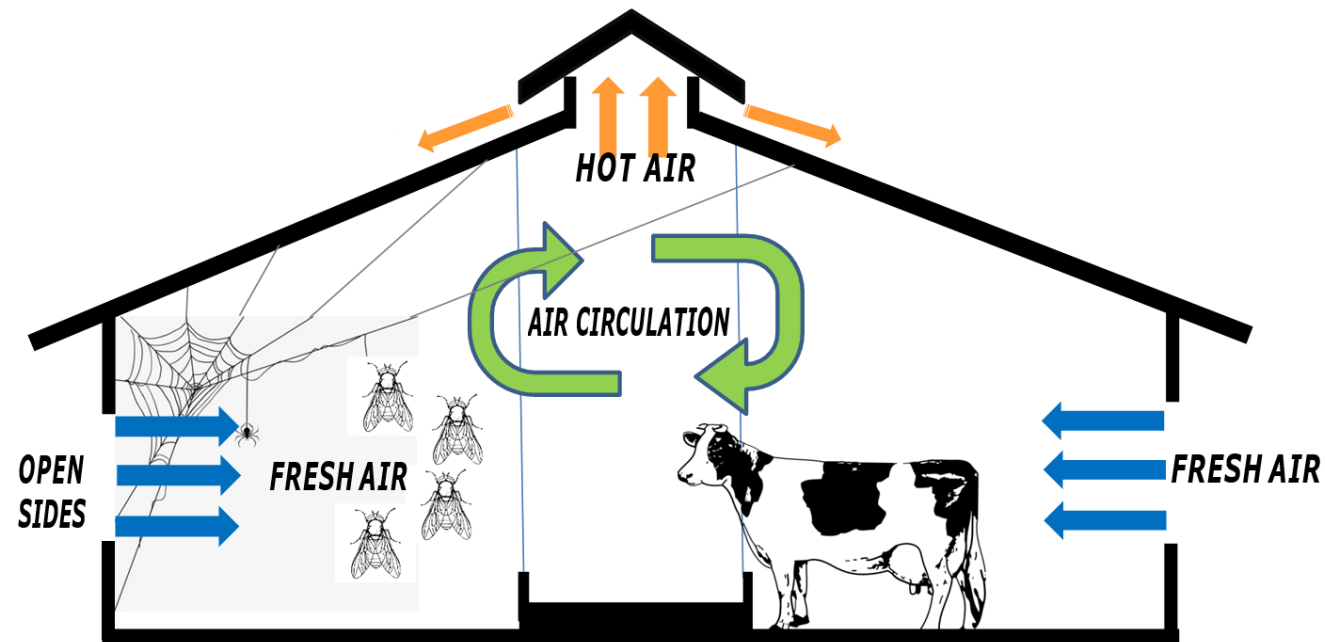

## 17. Floors

- Floor construction and detailing is the same irrespective of the choice of materials (wood/steel) for other barn elements.
- Floor construction is making concrete all walking and feed alley areas. Concrete is the most commonly used material of choice for building floors, pavements, driveways, sidewalks, steps, basements/pits and industrial floors.
- It is relatively inexpensive to install and provides an attractive, durable surface that is easy to maintain. Proper attention to the standard practices and procedures for constructing exterior or interior concrete, can yield a concrete surface that will provide long-lasting, superior performance.



## 17.1 Floors Cont'd...

For best results and quality concrete in construction projects, the following procedures are of great importance;

- Remove all vegetation, soft soils, and rocks so that support for the slab is uniform. If possible, place concrete on undisturbed, firm soil (stable ground).
- Set forms so that the concrete slab surface slopes a minimum of two percent, or 1/4 inch per foot, this provides adequate drainage.
- Use a poker vibrator to drive off trapped air and increase bonding ability in addition to a scratch template, typically, a piece of 2"-by-4" or 2"-by-6" lumber equal to the specified slab thickness, with stakes attached to the top surface at each end, or a string line across the top of the forms to ensure proper slab thickness.





## 17.2 Floors Cont'd...

- Do not use high-slump concrete. Control water additions at the truck. A good slump for most flatwork placed by hand, apply 5 inches (12.5 cm). For slabs struck off with mechanical equipment, apply 2 to 4 inches (5-10 cm).
- Even a high slump caused by admixtures can be detrimental as the paste content (and shrinkage) of the upper portion of the slab, can be greater than the lower portion of the slab leading to increased warping.
- Strike off the surface while keeping a small amount of concrete in front of the straightedge to fill in low spots. This helps to prevent birdbaths in the finished surface.





## 17.3 Floors Cont'd...

- Do not perform any finishing operation while bleed water is present on the surface. Do not dust dry cement on the surface to soak up bleed water.
- Use a machine to make grooves and/or contraction joints in the fresh concrete. Make sure the groove depth is one-quarter of the slab thickness. Or use expansion joints at predetermined spacing, or saw joints using either an early-cut saw or a conventional saw. Early jointing helps prevent cracking.
- Do not steel trowel concrete that contains more than 3% entrained air. Hard troweling of air-entrained concrete may cause surface deterioration.
- Start curing the concrete immediately after completion of finishing operations.



## 18. Flooring the walkway

- Construct high-quality concrete walkways, resistant to erosion and able to withstand a high load (i.e. manure scraping with walking or driven tractors).
- Assure sloping towards the direction of the manure dump: 1 to 2% (the red arrow showing direction from highest point A to the lowest point B)
- Assure sloping towards the center of the walkway: 1 to 2%, with the lowest point  $\geq 2$  m from the feed fence and  $\geq 1$  m from the curb of the beds.
- Provide enough grip for the cows to walk: don't polish.

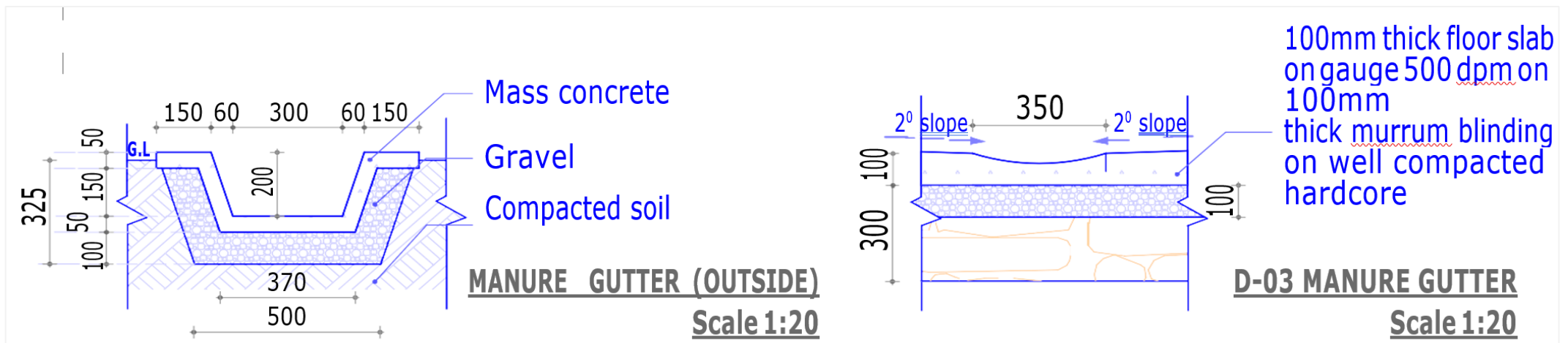

## 19. Instructions on construction of walkways for cows

- All walkways should be constructed of good quality concrete (15 cm thickness), with an iron concrete grid (diameter: 6 or 8 mm, grid distance: 15 cm).
- All longitudinal walkways should be on a slope of 1.5 to 2.5% (1.5 to 2.5 cm per 100 cm) in two directions: towards the centre and towards the manure dump.
- For easy cleaning, the holding pen can be built on a slope of 3-5 % away from the milking parlour towards the manure dump.
- To provide sufficient grip for the cows, the concrete must not be polished. And in most cases grooving is necessary. In barns with sand bedded cubicles, usually, it is not needed to groove the concrete.

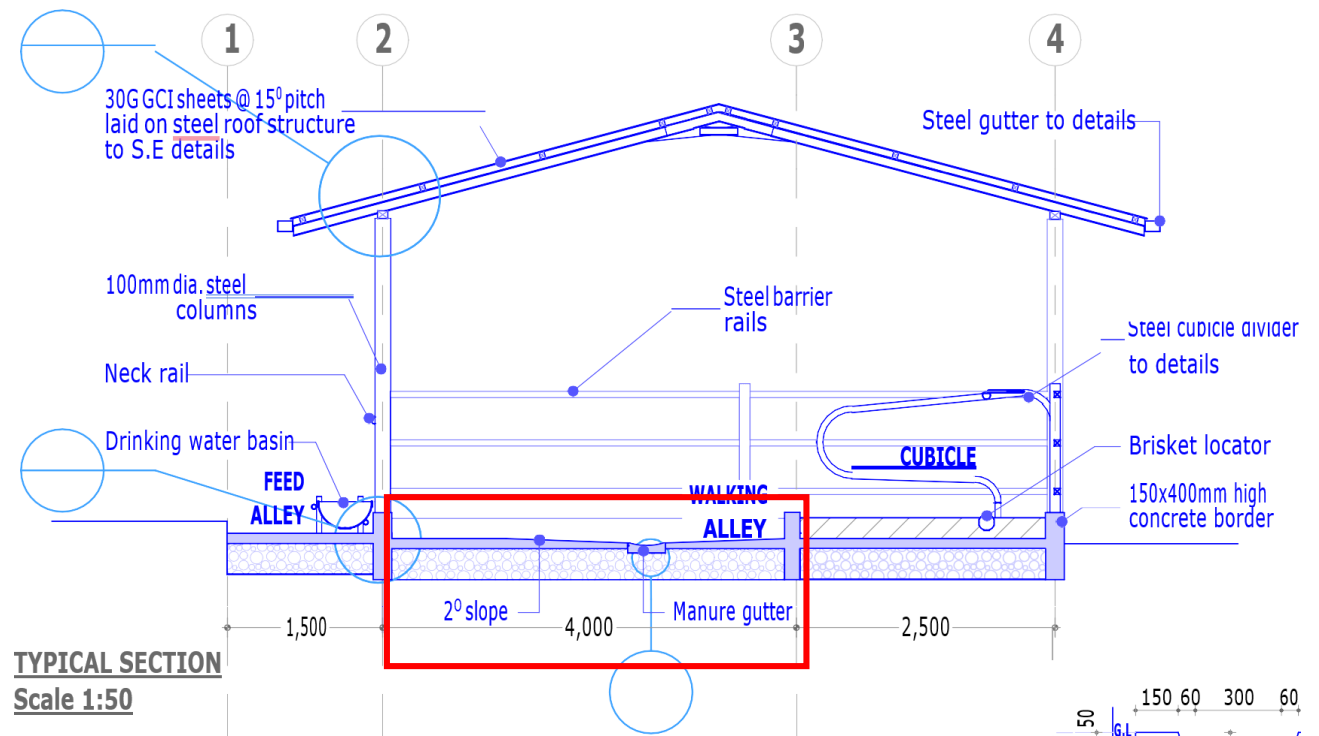

**Tip:** \*Contact your farm advisor to explain the detailed contraction information in the drawing.



## 20. Resting/laying areas

- The most important aspect of a cubicles is the flooring/bedding; this should be soft and dry.
- It should also be non-skidding to avoid slipping and falling when the cow lies down or gets up.
- By far the best bedding material is sand.
- Second best, close to the sand are deep bedding materials such as sawdust, (chopped) straw, rice hulls, dried manure solids and other dry materials that do not lead to the formation of hard lumps when used in the cubicles.





## 21. Cubicle bedding depth and quality

- Sand and dried manure depth should be at least 20cm deep (knee test) - See module 8.6, [Housing & cow comfort \(animal welfare\)](#).
- After the foundation soil on the cubicles the materials such as sawdust, (chopped) straws, and rice hulls should have a depth of at least 20cm.
- Remove manure and wet spots.
- After this leveling of the soft bedding material should be done two to three times per day.
- And if need be replacing these materials (because some materials removed with the manure) should be done daily to maintain comfort.

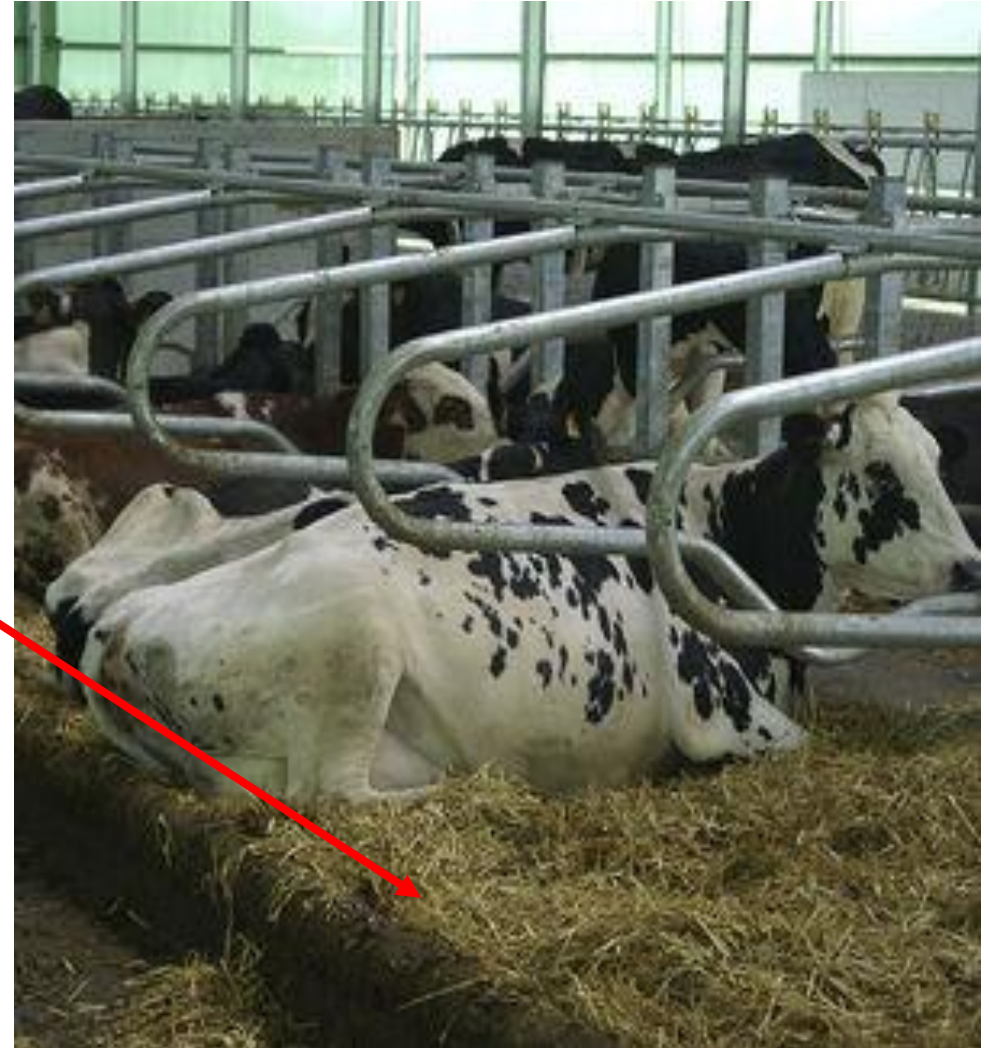

## 22. Cubicle bedding rubber mattress quality

- For the rubber mattresses option, it is recommended to use mattresses with thickness ranging from 40mm to 60mm.
- The mattresses should be one piece, not two or more layers. The layers are difficult to clean and water will go in between mattresses and/or between concrete and mattress. This needs to be avoided at all times to ensure the resting area does not become a source of bacterial infection for the udder.



## 23. Manure collection drain and manure bunker/pit

- Handling of cow manure is a very important operation of a dairy farm and requires much attention.
- Manure must be collected daily and put in a storage facility or bunker whose design depends on the volume, usage and destination of the manure.
- Manure (or biogas slurry, if the manure is first used to generate biogas) is stored over a longer period of time in a pit or bunker (preferably of concrete and with a cover), from where it is distributed periodically to agricultural land as an organic fertilizer.





## 24. Rain harvesting

- A guaranteed supply of good quality water is important to provide cattle with their daily water requirement and for cleaning. Rainwater catchment may be used to provide part of this, but it will not be sufficient to guarantee sufficient volumes year-round.
- It is advised that the farm be connected to a piped water supply system, or if necessary sinks a deep-well or borehole.
- Water storage tanks with sufficient storage capacity need to be present, in the event that the water supply gets temporarily disrupted.
- As a rule of thumb, the water storage capacity should be equal to a minimum of two days water requirement of the cows plus water needed for cleaning.

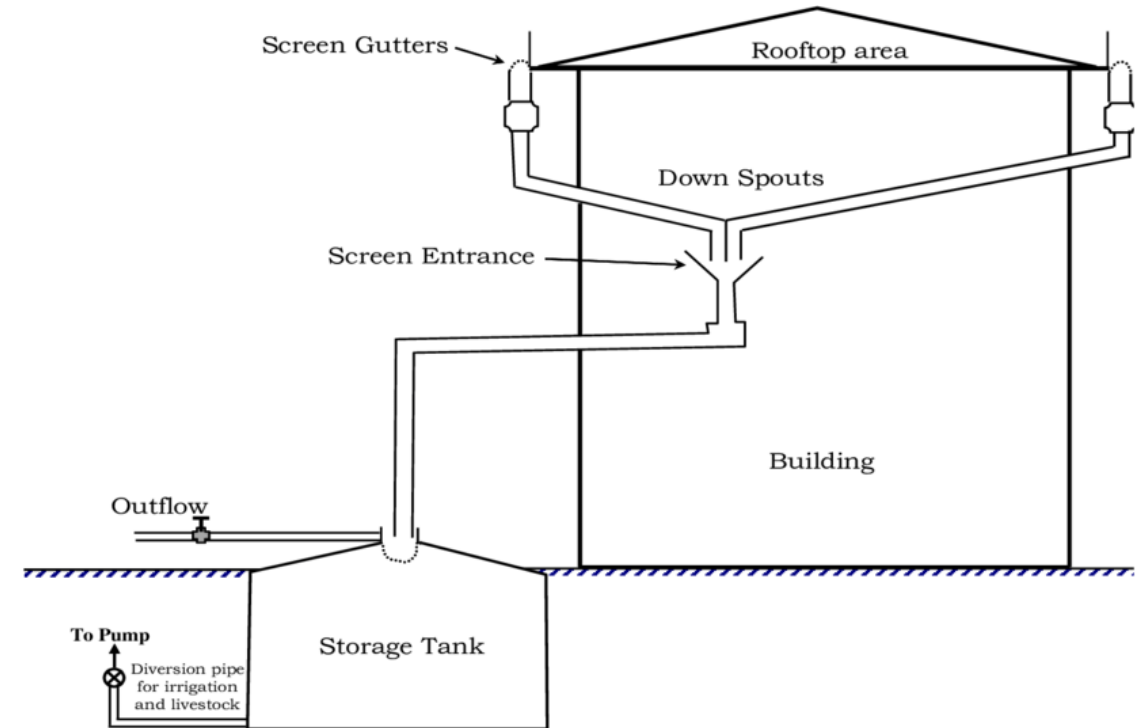



## 25. Cow barn maintenance

- **Roof gutters:** should be cleaned periodically, especially before rains to ensure rainwater collected in tanks is clean and free of contaminants.
- **Floors:** should be maintained in good repair condition to ensure safety of the cows and people working in the barn. Any damaged concrete floor surfaces should be repaired early to avoid extended damage to the entire floor area.
- **Wooden and steel members** such as structural posts and cubicle partition posts should be protected from long exposure to water and cow urine. Keeping steel and wooden posts dry most of the time prevents them from rusting and rotting, thus guaranteeing longer life span of the cow barn.

